

RESIDENTIAL DECKS AND THE 2020 MINNESOTA RESIDENTIAL CODE

Minnesota Department of Labor and Industry

General requirements and building permits

Effective March 31, 2020, residential exterior decks must be designed and constructed using the 2020 Minnesota Residential Code (MRC), related standards, manufacturer installation instructions, best practices and local jurisdiction zoning codes and ordinances.

Building permits are required:

- When a deck or a platform is more than 30 inches above adjacent grade.
- When a deck or platform is attached to a structure with frost footings.
- When a deck or platform is part of an accessible route.

Deck materials

All wood used in deck construction must meet requirements of MRC R507.2.1. This includes the grade of the wood (No. 2 or better), preservative treated or naturally durable lumber that has approval by the local jurisdiction. Preservative-treated wood must be appropriate for the installation and meet the American Wood Protection Association's (AWPA) UC3 (above ground) or UC4 (ground contact) use categories. All cuts, notches and holes in preservative-treated wood requires field treatment (MRC R317.1.1). All engineered wood products must meet the requirements in MRC R502.

Exterior deck boards, stair treads, guards or handrails made of plastic composite materials must meet certain performance standards in American Society for Testing and Materials (ASTM) D7302. Labels on materials or packaging will indicate compliance. Follow manufacturer's installation instructions for plastic composite materials.

Fasteners and connectors

Requirements for fasteners are in MRC Table R507.2.3 and R317.3. Fasteners (including nuts and washers) used in preservative-treated wood must be hot-dipped, zinc-coated galvanized steel, stainless steel, silicon bronze or copper. Staples used in preservative-treated wood must be stainless steel. Metal connectors in contact with preservative-treated wood should follow manufacturers recommendations and MRC Table R507.2.3.

Holes for bolts must be drilled between 1/32 and 1/16 of an inch larger than the bolt. Lag screws 1/2 inch or larger should be predrilled to avoid wood splitting.

Footings

Decks are required to be supported on concrete footings or other approved structural systems designed to accommodate all loads in accordance with the MRC. The use of alternative footings must be reviewed for approval by the local building safety department. Footings must be sized to bear loads and suitable for allowable soil-bearing

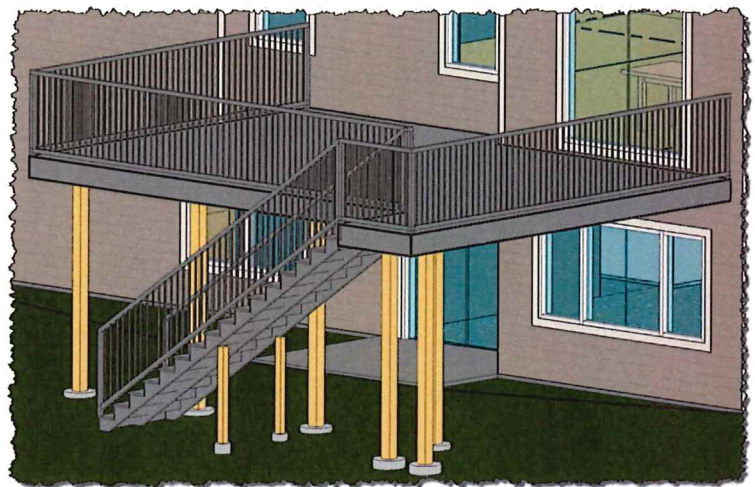

pressure (MRC Table R401.4.1). The minimum depths of footings must be either 5'-0" (Zone 1) or 3'-6" (Zone 2). Refer to Minnesota Rules 1303.1600 for the counties included in each zone.

Deck posts

Deck post sizing requirements are in MRC Table R507.4 and are limited to single-level wood-framed decks when sizing the decks other structural components with MRC Table R507.5. The height of the post shown in MRC Table R507.4 is measured from the underside of the beam to the top of the footing. Deck posts are based on using a 40 psf live load for structural member size calculations. Metal connectors must be provided at the top and bottom of posts for lateral restraint.

Beams

Allowable deck beam span lengths can be determined in MRC Table R507.5. Examples of the flush beams and dropped beams can be seen in the examples shown. Measurements of deck beam lengths need to be from center of post to center of post. The spans used in the table are based on a live load of 40 psf, a dead load of 10 psf, supporting deck joists from one side only and the beam depth must be greater than or equal to the joist depth when using a flush beam configuration. Beam plies shall be fastened with two rows of 10d (3-inch x 0.128-inch) nails or approved fasteners a minimum of 16 inches on center. Beams are allowed to cantilever up to one-fourth of their allowable span at each end.

Ends of beams used in splices must have a minimum of 1-1/2 inches of bearing on wood and 3 inches on concrete.

Multiple-span beams must have full bearing on posts (MRC Figures R507.5.1(1) and R507.5.1(2)). Those figures also show beam-to-post connections with metal connector plates and bolts and nuts configurations that are required by MRC R507.5.2.

Joists

Allowable spans for joists are in MRC Table 507.6. The live load used in the table is 40 psf and a dead load of 10 psf. The maximum cantilever length is determined by the lesser of one-fourth of the joist span or the maximum cantilever length shown in MRC Table 507.6. Joist spacing is limited by the span rating of the decking being used, see MRC Table R507.7.

Deck joists require a minimum of 1-1/2 inches of bearing on wood and 3 inches on concrete. Joist bearing on top of a single-ply beam or ledger shall be attached by a mechanical connector. Use the fastener schedule (MRC Table R602.3(1)) for fastening joists to a multiple-ply beam. Use an approved joist hanger for joist framing into the side of a beam or ledger board.

Where joist hangers or blocking are used, 60-percent of the joist depth must be restrained. If a rim joist is being used, not fewer than three 10d (3-inch x 0.128-inch) nails or three No. 10x 3-inch-long wood screws are required.

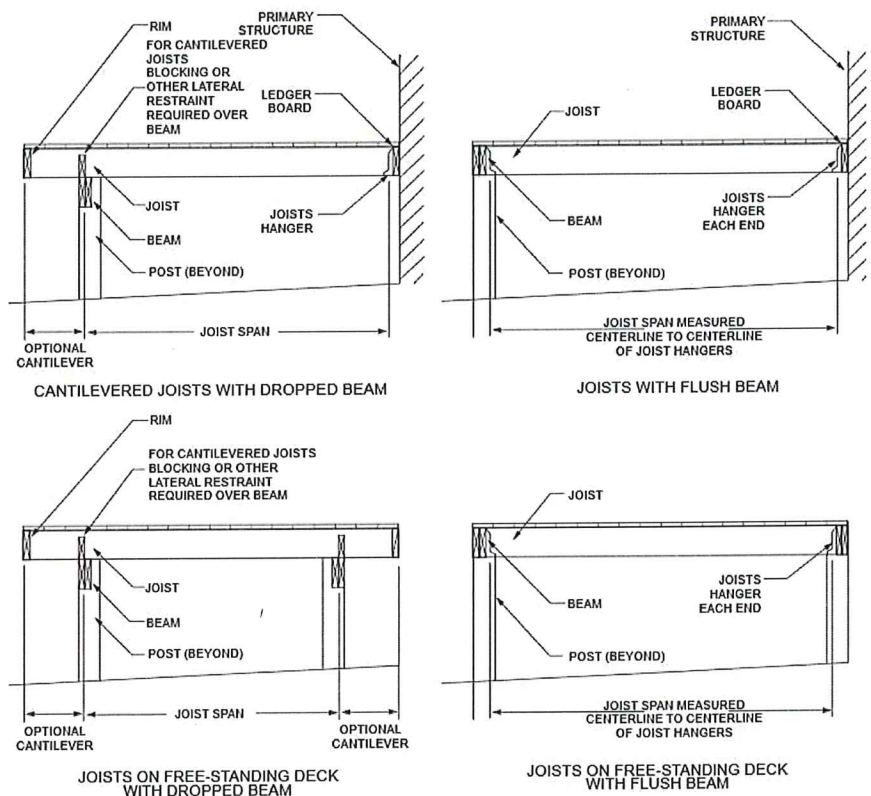

Decking

Use at least two 8d threaded nails or two No. 8 wood screws to attach wood decking to the joist. Other approved decking or fastener systems shall be installed in accordance with the manufacturer's installation requirements.

Ledger and band joist

A ledger board attached to the exterior wall of the primary structure must be at least 2-inch by 8-inch nominal. Pressure-preservative-treated Southern pine, incised pressure-preservative treated hem-fir, or approved, naturally durable, No. 2 grade or better lumber. Deck ledgers must not support concentrated loads from beams or girders and cannot be supported on stone or masonry veneer.

Band joists supporting a ledger must bear fully on the primary structure and be capable of supporting all required loads. Fasteners used in deck ledger connections in accordance with MRC Tables R507.9.1.3(1) shall be hot-dipped galvanized or stainless steel and shall be installed in accordance with Table R507.9.1.3(2) and figures R507.9.1.3(1) and R507.9.1.3(2). Where connections to the primary structure cannot be verified during inspection, decks must be self-supporting.

Lateral support

Lateral-load connection devices must be installed to transmit the lateral loads imposed on the deck to the ground. The lateral-load connection device shown in MRC Figure R507.9.2(1), with the threaded rod and connection points on the deck joist and the primary structure floor system, must be installed in two locations on the deck a minimum of 24 inches from the ends. Each device must have an allowable stress design capacity of at least 1,500 pounds.

Where the lateral load connections are provided in accordance with Figure R507.9.2(2), the hold-down tension devices must be installed in at least four locations per deck, and each device must have an allowable stress design capacity of at least 750 pounds. Hold-down tension devices are required to be installed per the manufacturer's instructions.

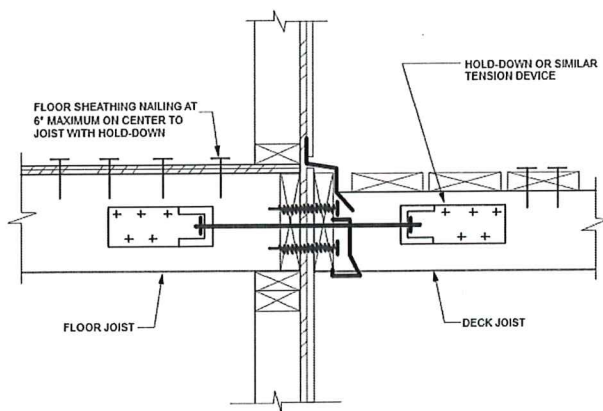

FIGURE R507.9.2(1)
DECK ATTACHMENT FOR LATERAL LOADS

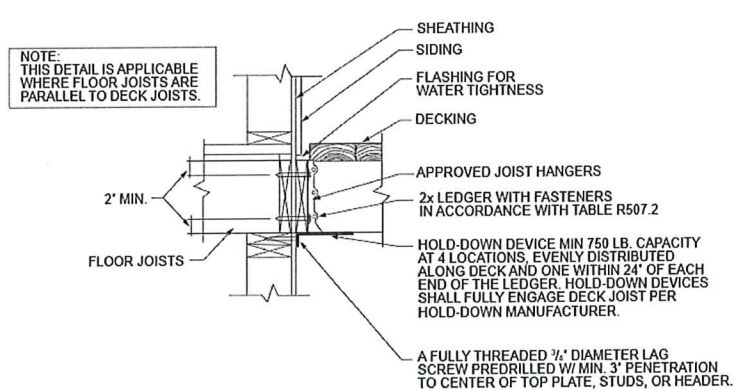
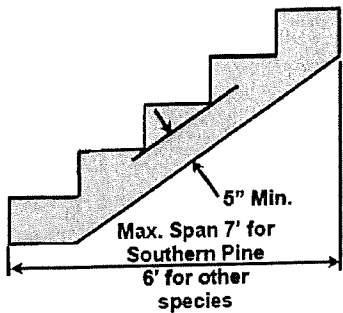
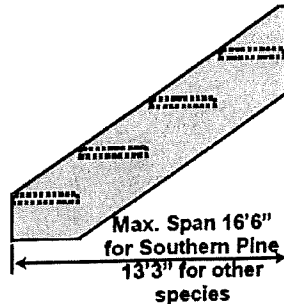

FIGURE R507.9.2(2)
DECK ATTACHMENT FOR LATERAL LOADS

STAIR STRINGER SPANS
LANDINGS OR COLUMNS AND BEAMS MAY BE USED TO SHORTEN STRINGER SPANS



CUT STRINGER



SOLID STRINGER

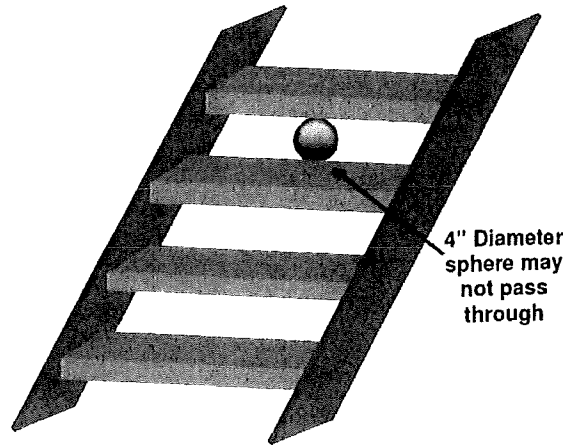

Guards and handrails

Guards and handrails must be provided as shown on the following illustrations. Guards must continue downstairs where the stair is more than 30 inches above grade. The height of guards on stairs must be 34 inches minimum and 36 inches minimum on horizontal surfaces.

Handrails must be provided on at least one side when there are four or more risers. Handrails must be continuous for the entire length of the stairs and may not be interrupted by newel posts except at landings. Handrails must have returns on each end or terminate into a newel post. Other handrail shapes having an equivalent gripping shape may be used with prior approval of the Building Department.

Handrails and guards must be designed to support a 200lb load applied in any direction at any point along the top of the guard or rail.

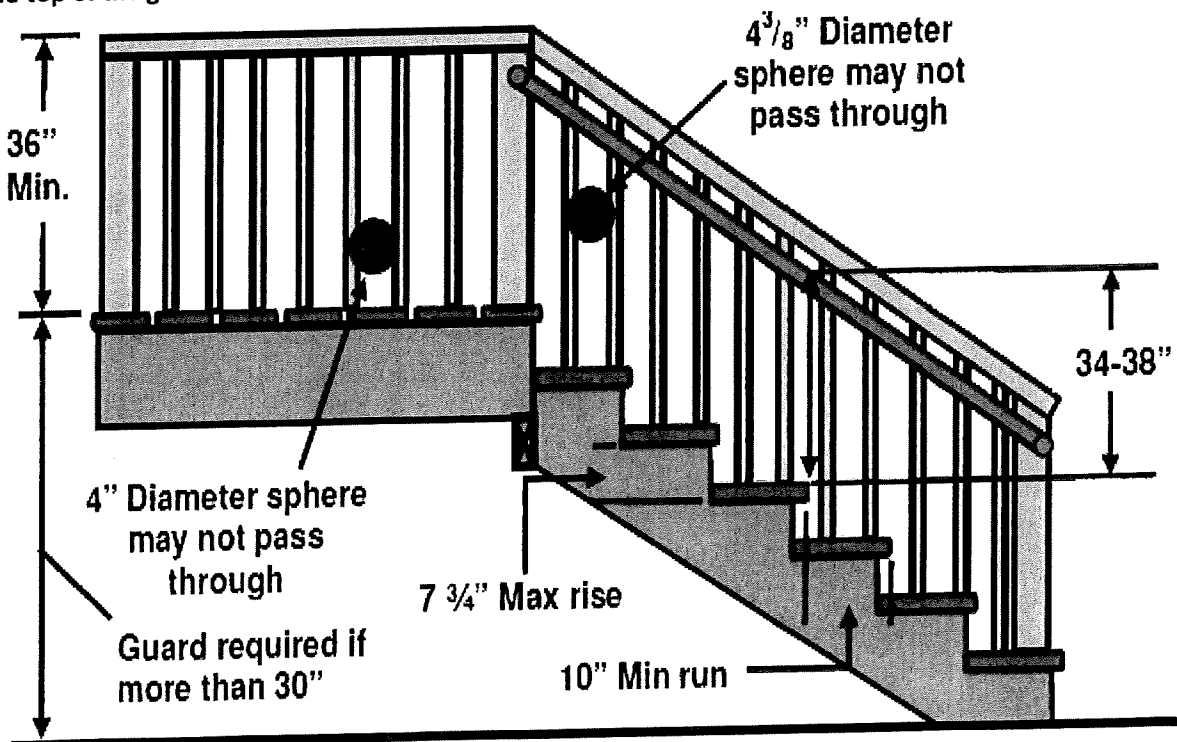

METHODS OF ATTACHING BEAM TO COLUMN

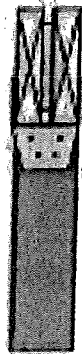

BEAM SECURED WITH POST CAP

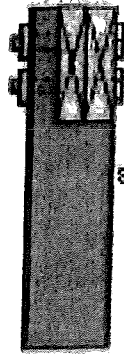

BEAM SECURED WITH BOLTS TO NOTCHED COLUMN

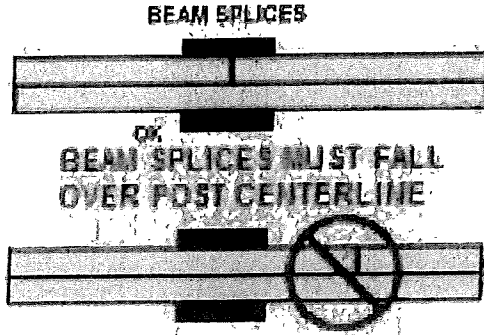

BEAM SPLICES
OK
BEAM SPLICES MUST FALL OVER POST CENTERLINE

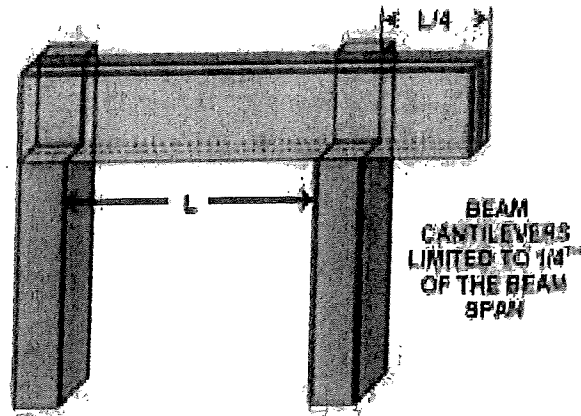

BEAM CANTILEVERS LIMITED TO 1/4TH OF THE BEAM SPAN

Columns

R507.4 Deck posts.

For single-level wood-framed decks with beams sized in accordance with Table R507.5, deck post size shall be in accordance with TABLE R507.4 DECK POST HEIGHT^a

DECK POST SIZE	MAXIMUM HEIGHT ^{a, b} (feet-inches)
4 x 4	6-9 ^c
4 x 6	8
6 x 6	14
8 x 8	14

For SI: 1 inch = 25.4 mm, 1 foot = 304.8 mm, 1 pound per square foot = 0.0479 kPa.

a. Measured to the underside of the beam.

b. Based on 40 psf live load.

c. The maximum permitted height is 8 feet for one-ply and two-ply beams. The maximum permitted height for three-ply beams on post cap is 6 feet 9 inches.

PLACEMENT OF LAG SCREWS AND BOLTS IN BAND JOISTS

LEDGER FLASHING DETAIL

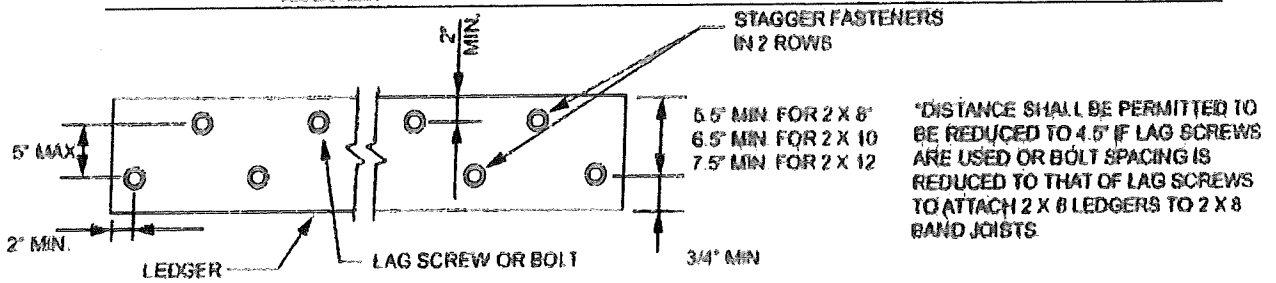
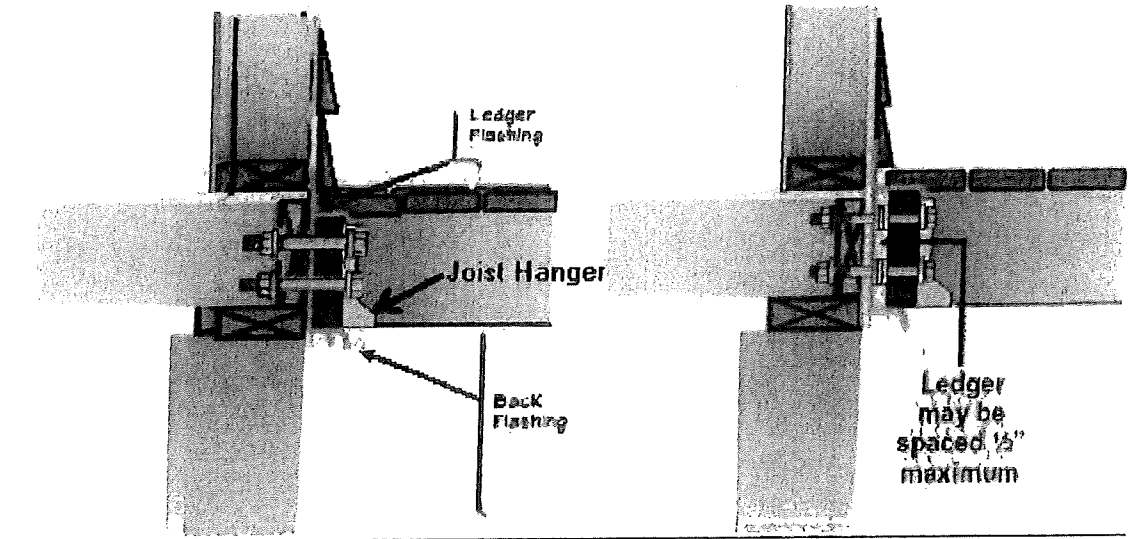

For Spacing = 25 3/4 in

FIGURE R507.9.1.3(1)
PLACEMENT OF LAG SCREWS AND BOLTS IN LEDGERS

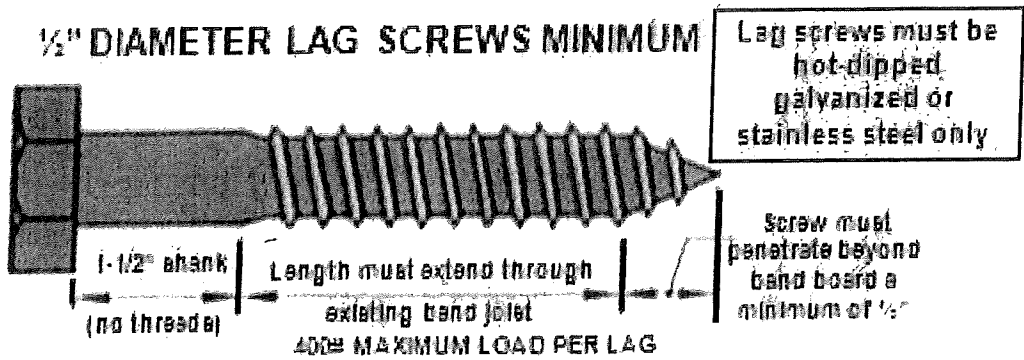

Deck Hardware

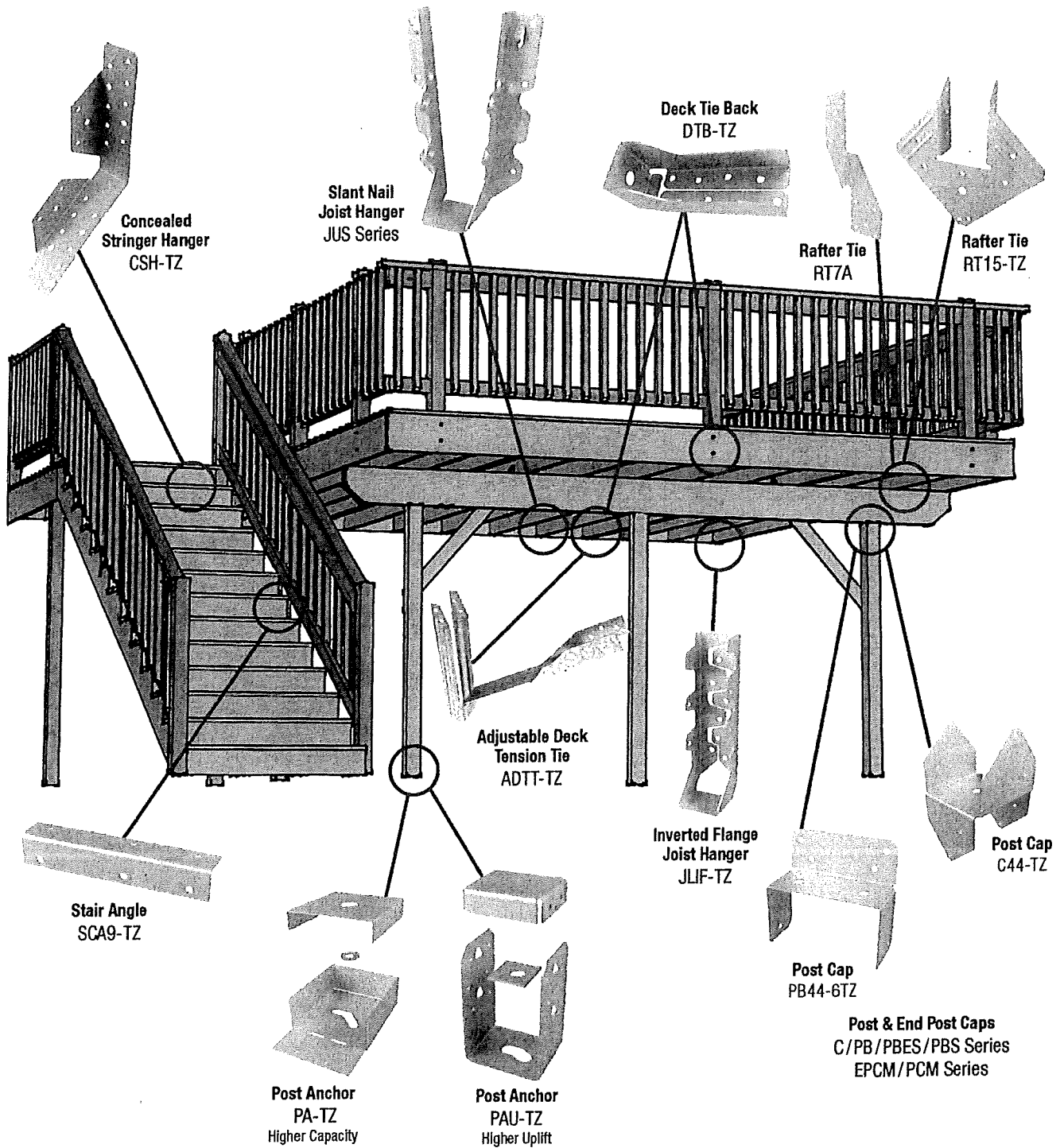

Disclaimer: Some of the products displayed are optional and not estimated

Customer Service 1-800-328-5934 • MiTek-US.com